

Installation Instructions

Part No. 22808 Speed Controller

Installation & Operation

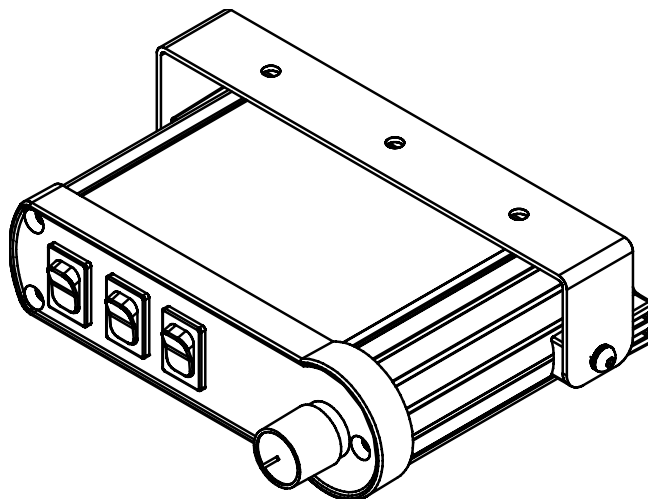

INSTALLATION INSTRUCTIONS (2 wire harness)

- A. Choose a convenient location to mount controller (1). Mount mounting bracket (2) inside vehicle cab using three #10 x 1/2" pan phillips head screws provided.
- B. Connect Black wire (10) from pigtail (7) to ground. Black Wire must be grounded before connecting any other wires. **Caution: Controller will be damaged if this is not followed.**
- C. Connect Blue wire (8) from pigtail (7) to brake light.
- D. Connect White wire (9) from pigtail (7) to vibrator white wire if equipped.
- E. Connect Red wire (11) from pigtail (7) to a 12 volt keyed accessory.
- F. Connect White jumper wire (5) to connector marked (motor white wire) on the back of the controller (1) and to matching connector on spreader harness.
- G. Connect Red jumper wire (6) to connector marked (Battery Red wire) on the back of the controller (1) and to matching connector on spreader harness.

#3 30 Amp fuse

#4 5 Amp fuse

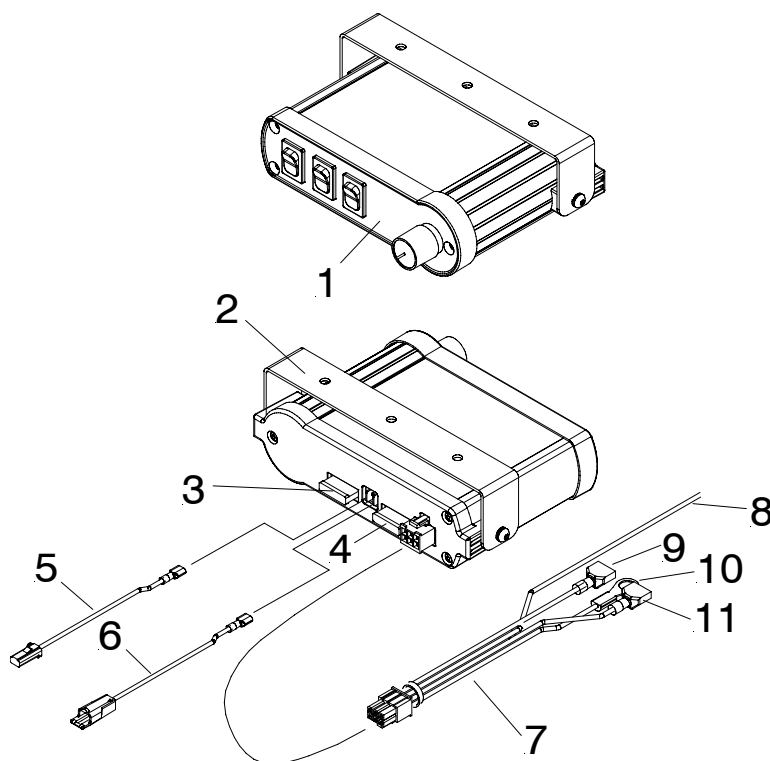

INSTALLATION INSTRUCTIONS (4 wire harness)

- A. Choose a convenient location to mount controller (1). Mount mounting bracket (2) inside vehicle cab using three #10 x 1/2" pan phillips head screws provided.
- B. Connect Black wire (10) from pigtail (7) to ground. Black Wire must be grounded before connecting any other wires. **Caution: Controller will be damaged if this is not followed.**
- C. Connect Blue wire (8) from pigtail (7) to brake light.
- D. Connect White wire (9) from pigtail (7) to vibrator white wire if equipped.
- E. Connect Red wire (11) from pigtail (7) to a 12 volt keyed accessory.
- F. Connect White jumper wire (5) to connector marked (motor white wire) on the back of the controller (1) and to matching connector (white wire) on spreader harness.
- G. Connect Red jumper wire (6) to connector marked (Battery Red wire) on the back of the controller (1) and to matching connector (red wire) on spreader harness.
- H. Connect brown and black wires on spreader harness together using Black jumper wire (12).

#3 30 Amp fuse

#4 5 Amp fuse

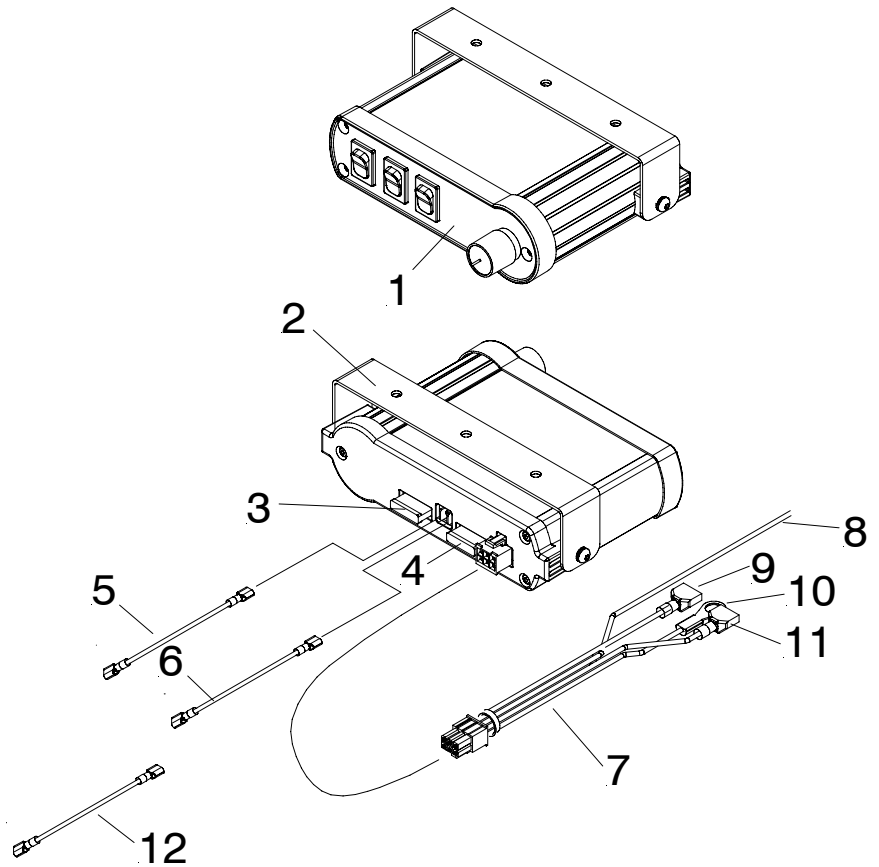

SPREADER CONTROLLER OPERATION

The controller is equipped with a power on switch, blast switch, vibrate switch and rotary speed control. Once the ignition key is turned to the ON position, the controller face plate will illuminate white indicating that the controller is ready for operation. During operation, face plate color will vary depending on the mode of operation and status of the controller.

To start the spreader, be sure that the vehicle engine is running to prevent battery from wearing down, flip the power switch to position I for normal mode or position II for auto mode. Once power switch is ON, the spreader will power up with 5 full blast for approximately one second then drop to wherever the dial has the speed set at. Adjust the speed of the spreader by rotating the dial clockwise for faster and counterclockwise for slower. The face plate will illuminate greener as the speed increases and will change completely to green at maximum speed.

If auto mode is selected, the face plate color will change to amber, the spreader will power up with 5 full blast for approximately one second then drop to wherever the dial has the speed set at. In this mode, if the brake is applied for more than 5 seconds, the spreader will stop and once the brake pedal is released, spreader will resume its operation.

The blast switch provides momentary full power override. During operation if blast switch is depressed, spreader will go on to full speed and the face plate color will change to blue.

If vibrator switch is flipped to the ON position I, vibrator motor will be activated as long as the switch is maintained at position I and the face plate will illuminate purple. If vibrator auto mode is selected at position II, vibrator motor will activate for 10 seconds every 60 seconds and will cycle the motor ON and OFF as long as the switch is maintained at AUTO position II. Face plate will change color to purple whenever the vibrator motor is activated.

In case there is an overload condition, the face plate will change to red color and the spreader will stop. The Power **ON / OFF or AUTO** switch will need to be turned OFF to reset the controller.